

Article number: 23052046113
 Description: E+G Handwheel
 EMW.350+IEL-A20-C3

Measures

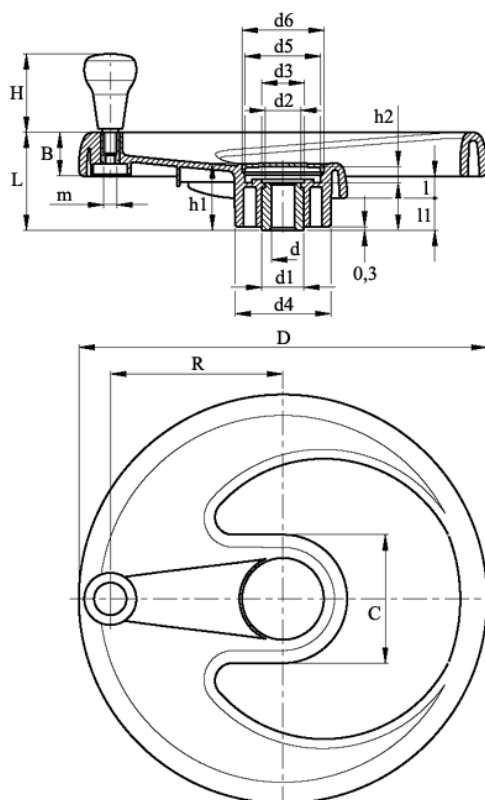

B = 38	d6 = 70	l1 = 25
C = 108	d H7 = 20	m = M10
D = 350	h = 38	R = 148
d1 = 35	H = 65	
d2 = 33	h1 = 55	
d3 = 35	h2 = 14	
d4 = 82	l = 19	
d5 = 69	L = 82	